

Universal 4-wire Transmitters and Trips SC - 7400

- Universal input
- 0.1% Accuracy
- Optional built-in intrinsic safety barriers.
- Quick and simple - No pots or switches to set.
- Continuous Self-calibration
- High density - DIN mount
- Modular design
- Password Protection

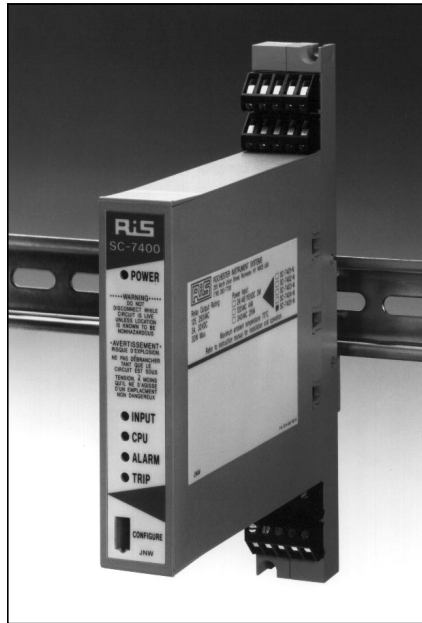

The SC-7400 is an intelligent, universal input signal conditioner/alarm trip that isolates and transmits the status of process signals on a single control loop basis. It handles a variety of temperature and process inputs and offers combinations of analog and relay contact outputs.

All parameters - such as input and output range, setpoints, deadband and burnout - are customer-selectable via software.

Operate it on a PC with easy-to-use Windows based software or with an optional hand-held configurator for easy, on-site configuring and re-configuring of modules. Alternatively, opt for the factory to perform a custom configuration to meet your needs.

The SC-7400 series incorporates state-of-the-art technology to provide:

- safe, reliable monitoring of plant and machinery
- peak operation for your equipment
- reduced overall system cost and calibration efforts
- the highest density available in smart technology
- the highest level of operational diagnostics and accuracy

With the SC-7400, one unit can be programmed to meet numerous applications ... and you may purchase it with optional intrinsic safety barriers that meet CSA and FM agency requirements. Functional benefits include detachable field wiring, password protection, integrity diagnostics, full software programmability, high packing density, low spare inventory, and EMC immunity.

Fully trained Rochester representatives are equipped with demonstration units for customer selection assistance.

SC-7401 Single analog output

SC-7402 Dual analog output

SC-7403 Single alarm output

SC-7404 Dual alarm output

SC-7405 Single analog and alarm output

ROCHESTER

Signal Conditioning

Specifications

Indicators

Power	Green LED
Input sensor	Green LED (on = OK)
Module Operation	Green LED (on = OK)
Alarm 1	Red LED (on = alarm)
Alarm 2	Red LED (on = alarm)

Power Supply

Jumper selectable for 24V DC, 48V DC, 110V DC, 120V AC 50/60 Hz nominal.

Input Signals

DC Volt (Non IS Models only):

0 to 1V, 0 to 5V, 0 to 10V, 1 to 5V, 0 to XV (special factory configuration X=20 to 200V (30 V maximum for CSA))

DC Current (Non IS Models only):

0 to 1 mA, 0 to 5mA, 1 to 5mA, 0 to 10mA, 0 to 20 mA, 4 to 20 mA, 10 to 50 mA, 0 to 5 mA Bipolar, 0 to 10 mA Bipolar

DC mV (All models):

-15 to +85 mV absolute operating range. Zero and span may be set anywhere within range. 4 mV minimum span.

T/C (All models):

Software configurable for linearized or non-linearized output

Ohms - 3 or 4 wires (All models):

0 to 500 Ω absolute operating range. Zero and span may be set anywhere within range. 50 Ω minimum span

RTD (All models) - 2, 3 or 4 wire, 3 wire differential for Pt and Ni RTD, 2 wire only for Cu RTD:

100 Ω Pt $\alpha=0.003850$, -200 to +850°C, Min span 50°C

100 Ω Pt $\alpha=0.003916$, -200 to +850°C, Min span 50°C

100 Ω Pt $\alpha=0.003923$, -200 to +650°C, Min span 50°C

120 Ω Ni, -80 to +320°C, Min span 50°C

10 Ω Cu, -200 to +260°C, Min span 460°C

Slidewire (Non IS Models only):

May be configured for 500 to 5000 Ω span based at zero ohms

Input Accuracy:

mV: $\pm 0.02\%$ of reading ± 0.005 mV, Linear with input

V: $\pm 0.05\%$ of reading ± 0.6 mV, Linear with input

mA: $\pm 0.05\%$ of reading ± 3.0 μ A, Linear with input

T/C: Accuracy listed in table plus cold junction error

T/C Type	Range °C	Accuracy	Min/Max Span \pm °C
NIST - J	-180 to 760	$\pm 0.3^\circ$ C	110 to 940
NIST - K	-180 to 1300	$\pm 0.5^\circ$ C	140 to 1480
NIST - E	-150 to 1000	$\pm 0.3^\circ$ C	90 to 1150
NIST - R	0 to 500	$\pm 1.0^\circ$ C	450 to 1600
	500 to 1600	$\pm 0.7^\circ$ C	
NIST - S	0 to 500	$\pm 1.0^\circ$ C	480 to 1600
	500 to 1600	$\pm 0.7^\circ$ C	
NIST - T	-200 to 0	$\pm 0.4^\circ$ C	160 to 600
	0 to 400	$\pm 0.3^\circ$ C	
NIST - B	300 to 500	$\pm 2.0^\circ$ C	650 to 1500
	500 to 1800	$\pm 1.0^\circ$ C	
BS* - N	0 to 800	$\pm 0.3^\circ$ C	140 to 1300
	800 to 1300	$\pm 0.5^\circ$ C	
DIN - J	-200 to 900	$\pm 0.3^\circ$ C	110 to 1100
DIN - T	-200 to -100	$\pm 0.4^\circ$ C	160 to 800
	-100 to 600	$\pm 0.3^\circ$ C	

* British Standard

Cold Junction Error: $\pm 0.5^\circ$ C

Non-Linearized T/C:

$\pm 0.02\%$ of reading ± 0.005 mV plus cold junction accuracy

Analog output signals

Software configurable current outputs: Voltage outputs configurable through software and external terminal block wire jumper:

Range	Max load	Range	Impedance
0 - 1mA	1600 k Ω	0 - 1V	1 k Ω
0 - 5 mA	3200 k Ω	0 - 5V	1 k Ω
0 - 10 mA	1600 k Ω	1 - 5V	1 k Ω
0 - 20 mA	800 Ω	0 - 10V	1 k Ω
4 - 20 mA	800 Ω		

Relay output

Contact Rating (trip outputs): 3A, 250V AC resistive or 3A, 30V DC, 30W max., SPDT

Trip Range: 0.5 to 100% of span in 0.15% increments

Deadband: 0 to 20% of span in 1% increments

Analog Output Accuracy:

0 to 5mA, 0 to 5V, 1 to 5V output ranges: $\pm 0.1\%$ of span, all other analog output ranges: $\pm 0.05\%$ of span

Tracking Accuracy (SC-7402 only):

4 to 20 mA $\pm 0.5\%$ max - others $\pm 1\%$ typical

Trip Output Accuracy:

$\pm 0.01\%$ of span

Functional Characteristics

Analog Output Step Response:

For a step of 0 to 100% of span the 10 to 90% response time is less than 0.5 second. The response time from input change to 90% output change is less than 1 second.

Trip Output Step Response:

For a step of 0 to 100% and the delay

set to zero the trip will occur within 0.5 second.

Input Impedance:

T/C, mV: Greater than 2 M Ω

mA: 50 Ω $\pm 5\%$

V: 500 K Ω $\pm 5\%$

RTD Excitation:

165 μ A $\pm 10\%$

RTD Failure:

Open Lead: Upscale

Shorted RTD: Downscale

Sensor OK LED turned off with sensor failure. Failure defined as 5% over or under the selected input range or input channel out of range. Analog output configurable for either upscale or downscale burnout. Trip output configurable for alarm if sensor fails.

T/C Burnout Current:

Less than 0.1 μ A

T/C, mV, mA, V Failure:

Sensor OK LED turned off with sensor failure. Failure defined as $\pm 5\%$ over or under the selected input range or input channel out of range. Analog output configurable for either upscale or

downscale burnout. Trip output configurable for alarm if sensor fails.

Dielectric Strength:

2.5kV AC 50/60 Hz from input to output/power/ground
 1KV AC from power to output/ground
 1KV AC between output and ground
 1KV AC between analog and relay outputs if applicable

Insulation Resistance:

Less than 5 M Ω at 500V DC after 1 minute

Leakage Current:

Less than 1 mA at 2500 VAC after 1 minute

Long Term Stability:

Less than 0.1% of span over 6 months

Warm Up:

Full accuracy within 5 minutes of power applied

Power Consumption:

DC: Nominal 2.5 W with one transmitter or trip output (transmitter output at 20 mA or relay on).
 Nominal 3.0 W with two outputs (same conditions)

120V AC, 50/60Hz: Nominal 4 VA at a leading power factor

Weight: 0.18 lbs (0.4 Kg)

Specifications subject to change without notice.

Operating Influences

Input Reference Conditions:

mV: 0 to 10 mV
 T/C: 0 to 200 °C "J" T/C
 RTD: 0 to 200 °C 100 Ω Platinum
 Ohm: 0 to 100 Ω

Analog Output Reference Condition:

4 to 20 mA, 250 Ω load

Ambient Temperature:

Nominal: 23 \pm 1°C
 Operating Range: -20 to +70°C
 Storage Range: -40 to +85°C
 Effect on Accuracy: \pm 0.005%/°C max.
 For Current Input \pm 0.0075%/°C max.
 For Copper RTD Input \pm 0.01%/°C max.
 Effect on Cold Jct: \pm 0.015°C/°C max.

Relative Humidity:

Range: 25 to 95% non-condensing
 Effect on Accuracy: $<$ 0.075% of span for a change in RH of 25 to 95% at 23 °C

Vibration Effect:

Range: A constant displacement of 1mm over the range of 5 to 15 Hz, and an acceleration of 5 m/s/s over the range of 15 to 150 Hz

Effect on Accuracy: $<$ 0.05% of span
 Drop and Topple: $<$ 0.05% of span

Common Mode Effect:

$<$ 120 dB at 120V AC 50/60 Hz

Normal Mode Effect:

$<$ 40 dB with peak to peak signal within maximum input range

Supply Voltage:

Nominal: 24V DC, 48 VDC, 110 VDC, 120 VAC 50/60 Hz

Range: $<$ 0.15%

Effect on Accuracy: $<$ 0.05% of span over the range

Magnetic Field Effect:

$<$ 0.05% of span at 0.5 mT, 50/60 Hz

Electromagnetic Susceptibility:

$<$ 0.1% of span over the frequency range of 20 to 1000 MHz at a field strength of 10V/M

$<$ 0.2% of span over the frequency ranges of 50-55 MHz and 95-115 MHz at a field strength of 1V/M

Tested to: IEC 801.3 Level 2

SWC Protection:

Conforms to IEC 801-4 level 2

ESD (electric discharge):

IEC801-2 level 3 (8kV), No permanent damage

Agency Approvals

Ordinary location:
 FM: FM3810 ANSI/ISA S82.01, S82.02, S82.03

CSA: C22.2 NO.142
 Surge withstand capability: per CEI/IEC 801-4 level 2

Intrinsic safety

Hazardous location:
 FM: FM-3610
 Class 1, Div. 1, Groups A, B, C & D

CSA: C22.2 NO. 157
 Class 1, Div. 1, Groups A, B, C & D

Division 2:

FM: FM-3611
 Class 1, Div. 2, Groups A, B, C & D

CSA: C22.2 No. 213

SC-7400 Dimensions

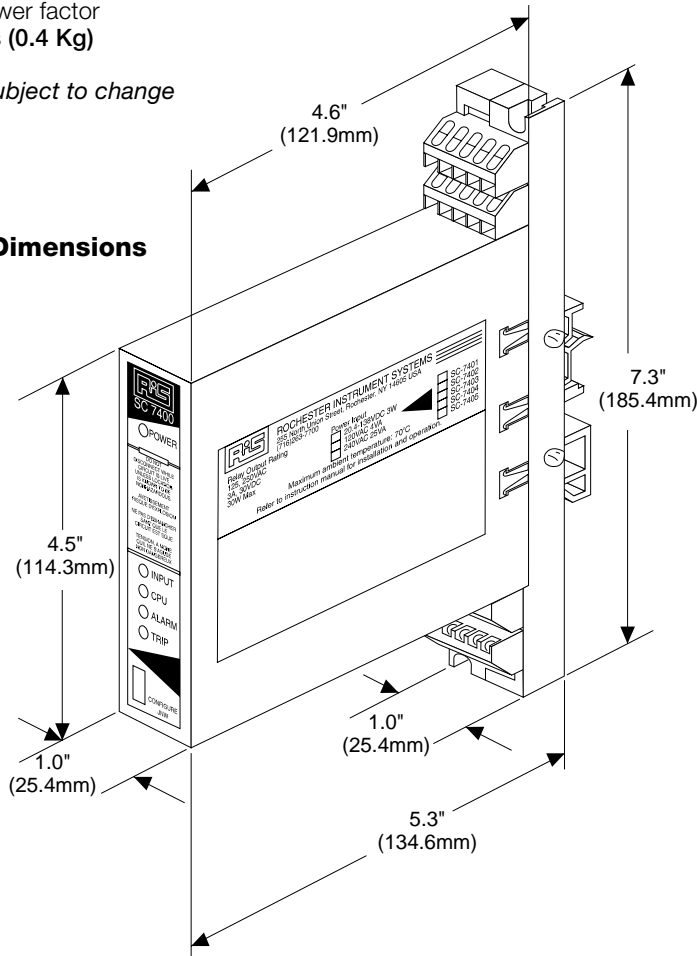

ROCHESTER

Signal Conditioning

Inputs

2-Wire Ohm, RTD

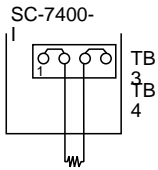
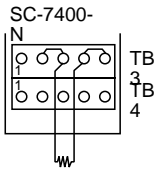

3-Wire Ohm, RTD

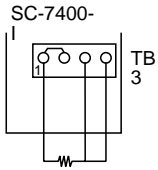
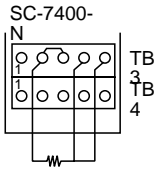

4-Wire Ohm, RTD

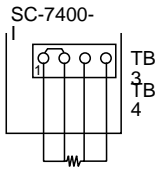
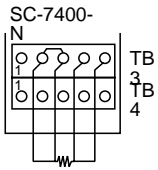

3-Wire Differential, RTD

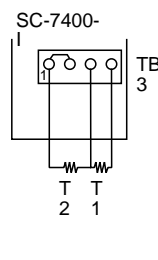
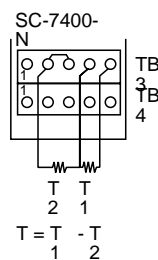

Slidewire

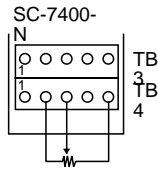

SC-7400-
NOT AVAILABLE

Current

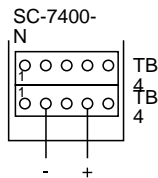

SC-7400-
NOT AVAILABLE

mV, T/C

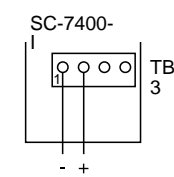
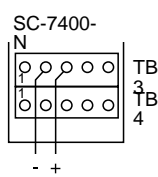

Volts

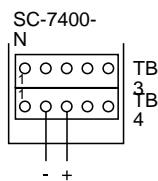

SC-7400-
NOT AVAILABLE

SC-7401-N, SC-7402-N, SC-7401-I and SC-7402-I

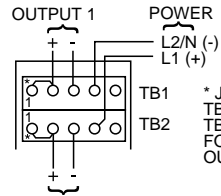

* JUMPER TB1-1 TO TB1-2 AND TB2-1 TO TB2-2 FOR VOLTAGE OUTPUTS ONLY

OUTPUT 2
(SC-7402-N, SC-7402-I ONLY)

SC-7403-N, SC-7404-N, SC-7403-I and SC-7404-I

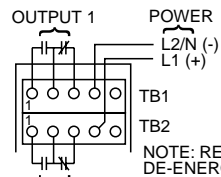

NOTE: RELAYS SHOWN IN DE-ENERGIZED STATE

OUTPUT 2
(SC-7404-N, SC-7404-I ONLY)

SC-7405-N, SC-7405-I

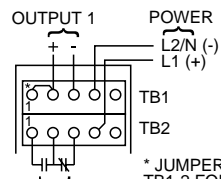

* JUMPER TB1-1 TO TB1-2 FOR VOLTAGE OUTPUTS ONLY

NOTE: RELAYS SHOWN IN DE-ENERGIZED STATE

Ordering Information

Model	Description
SC-7401	Single Analog Output
SC-7402	Dual Analog Output
SC-7403	Single Alarm Output
SC-7404	Dual Alarm Output
SC-7405	Single Analog and Single Alarm Output
	Code Intrinsic Safety Option
	N Non-intrinsically safe unit and base plate
	I Intrinsically-safe unit and base plate
	Code Base plate mounting
	S Surface mount
	R DIN rail mount base plate
	Code Configuration
	NC Not configured
	FC Factory configured
SC-7401	I S NC Ordering Example